

About Us WWW.AQUAGENESI.COM

Fitting for Potable Water,
Beverages & Drink Dispense

1
Reliable product

2
Easy operation

3
Pure and Safe

AQUA GENESI



Metric Size Fitting / Inch Size Fitting / Large Size Fitting

- One-touch type enabling easy to attach and detach, safe use
- Cork-type allowing excellent sealing function and high durability against leakage
- Made of FDA-approved material ensuring its safety, certified as NSF 51, 61
- Food and beverage fittings with oval sleeves

- 
- Check Valves**
Non-return valve that allows fluid to flow only in one direction
Usable for water, food and beverage
Compact size for convenient use in narrow spaces
Easy to install and convenient to use
- 
- Flow Control Valves**
Valve that discharges constant flow by controlling small flow rate
Usable for water, food and beverage
Flow rate increase / decrease controller available under any spatial changes
Securable stability under any temperature changes
- 
- Ball Valves**
Valve to open and close the supply of compressed air and water
Usable for air and water, convenient for use in confined spaced
Size-adjustable to fit in the hose and securable to valid cross sectional area as hose size
- 
- Filter Strainers**
Usable for water, food and beverage
Filter out fine impurities with stainless steel filter net
Easy filter installation and replacement
- 
- STEELFIT**
Nut and holder with two O-rings provide a stronger seal
Allowing the use of stainless pipe or similar tube
- 
- Cartridges**
Effectively inserting and using a counterpart with a cavity in the counterpart
Composed of half & full cartridges made of acetal and brass materials
- 
- Accessories**
Usable for water, food and beverage
Made of FDA-approved material ensuring its safety, certified as NSF 51, 61
- 
- Tube**
Water purifier, coffee machine, food and beverage hose
Available for various range of temperatures and pressures
Excellent chemical durability
Compliance with FDA standards

Applications and Features



- Our products are designed for water, food and air contact but can be used with selected gases, vacuum & liquids
- A single action allows the tube to release and connect easily, saving time and expense
- Our products are made of NSF approved non-toxic materials
- Various uses depending on the user's environment and application

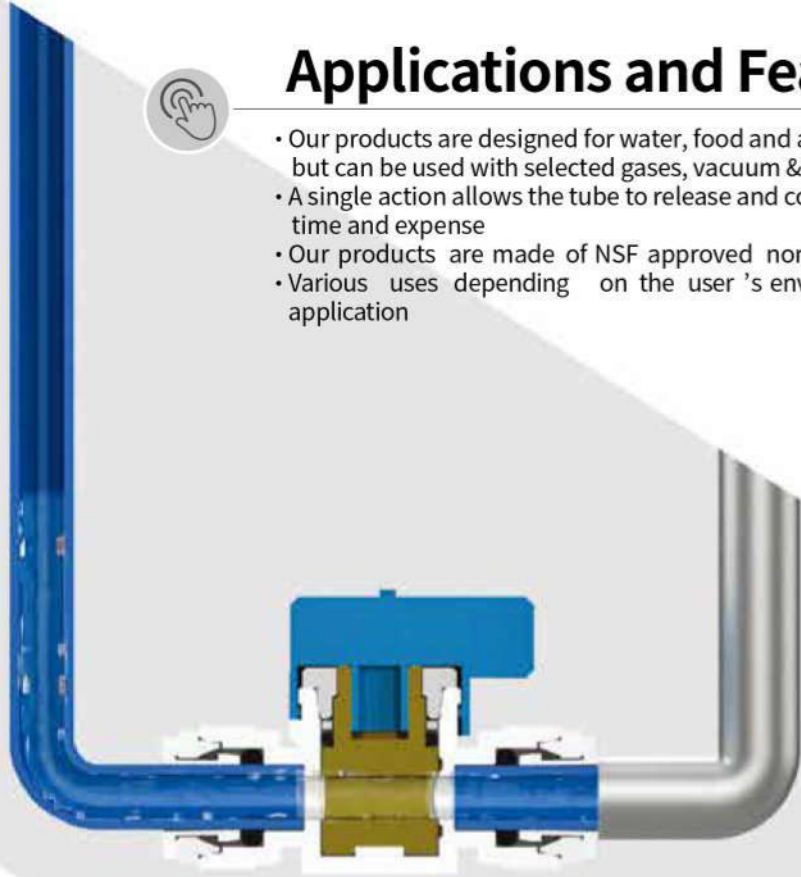

W270 KTW

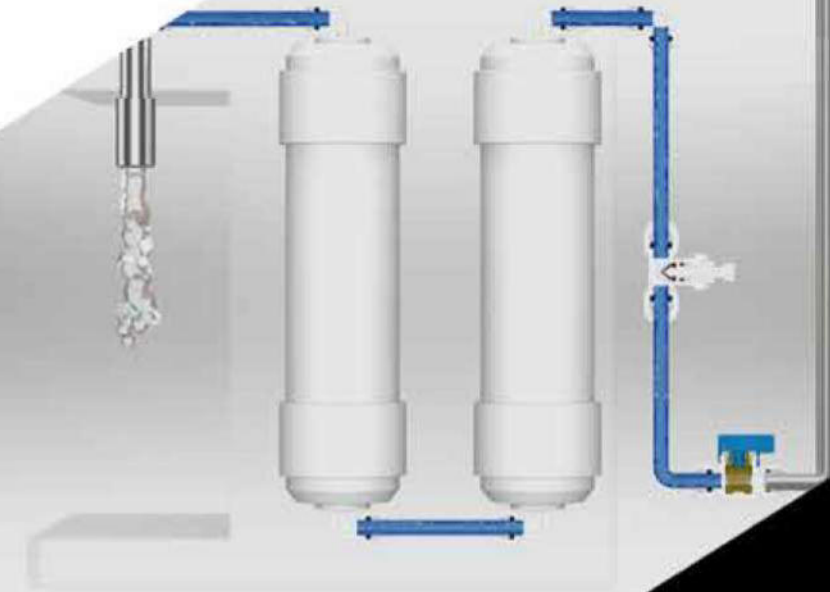

PUSH-IN FITTINGS

Structural Diagram

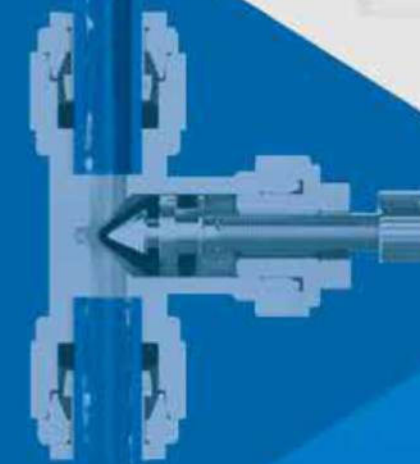
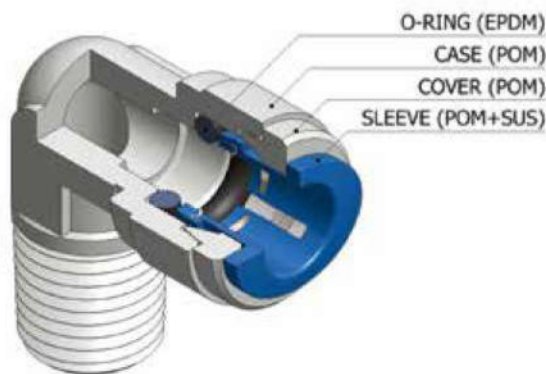

Specifications

- Our products are designed for water, food and air contact
- Fluid type : Water, Beverages
- Working pressure : 0~230PSI / 0~16kgf/cm²
- Working temperature : 34~140° F / 0~60°C
- Applicable Tube : Polyethylene(PE), Polyamide(PA), and Polyurethane(PU)
- Reference data(next page)

Naturally high-quality,
improved by technology.

Reference data

• Fluid type : [Water](#), [Beverages](#)

• Tube type : [Polyethylene\(PE\)](#),
[Polyamide\(PA\)](#) and [Polyurethane\(PU\)](#)

• Working Pressure & Temperatures

∅	°C	-20°C	1°C	25°C	70°C	98°C
4mm 5/32"	0 Bar→8 Bar with dry air only	-750 mmHg→20 Bar	-750 mmHg→20 Bar	-750 mmHg→20 Bar	-750 mmHg→16 Bar	-750 mmHg→10 Bar
6mm 3/16" ~1/4"		-750 mmHg→20 Bar	-750 mmHg→20 Bar	-750 mmHg→20 Bar	-750 mmHg→16 Bar	-750 mmHg→10 Bar
8mm 5/16"		-750 mmHg→20 Bar	-750 mmHg→20 Bar	-750 mmHg→20 Bar	-750 mmHg→16 Bar	-750 mmHg→10 Bar
10mm 3/8"		-750 mmHg→16 Bar	-750 mmHg→16 Bar	-750 mmHg→16 Bar	-750 mmHg→14 Bar	-750 mmHg→10 Bar
12mm 1/2"		-750 mmHg→14 Bar	-750 mmHg→14 Bar	-750 mmHg→14 Bar	-750 mmHg→8 Bar	-750 mmHg→6 Bar
15mm		-750 mmHg→14 Bar	-750 mmHg→14 Bar	-750 mmHg→14 Bar	-750 mmHg→8 Bar	-750 mmHg→6 Bar
22mm		-750 mmHg→14 Bar	-750 mmHg→14 Bar	-750 mmHg→14 Bar	-750 mmHg→8 Bar	-750 mmHg→6 Bar

- Temperatures and Pressures indicated refers to NSF standards limits, Please contact our technical department for higher temperature and /or pressure application.
 - System performances always depend from fittings, tubes and possible other items and accessories used.
- It is a responsibility for users to cross check the technical characteristics of each single component

Connection & Disconnection

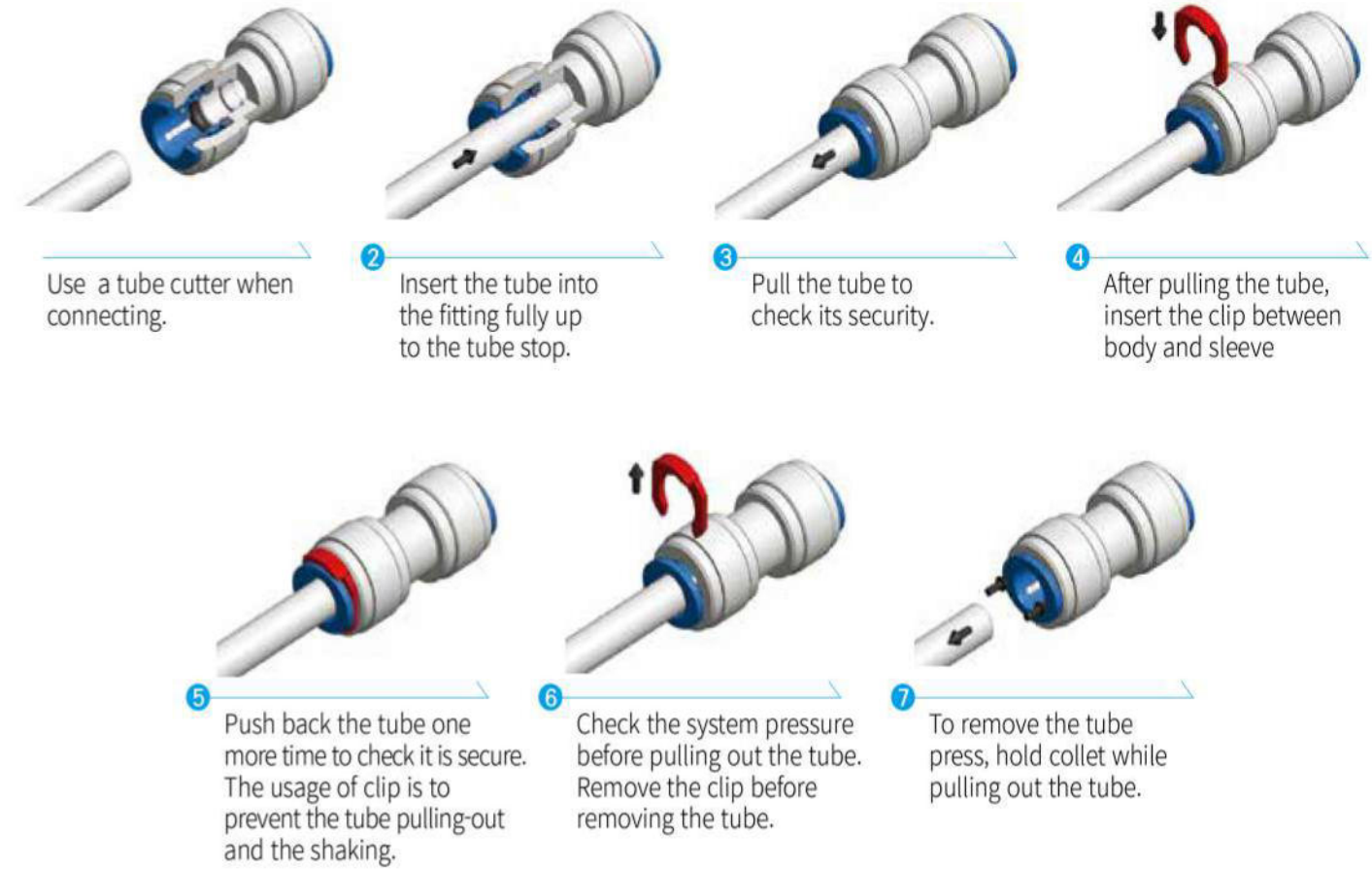



Metric Fitting

Male Connector

HPC



AQUA PART NO	TUBE (Metric)	THREAD (R)	Qty/Box	PRICE (€)
01.00517	06	R1/8	100	1,18
01.00586	06	R1/4	100	1,00
01.00518	06	R3/8	50	1,45
01.00296	08	R1/8	100	1,22
01.00297	08	R1/4	50	1,24
01.00520	08	R3/8	50	1,45
01.00298	08	R1/2	50	1,47
01.00299	10	R1/4	50	1,42
01.00300	10	R3/8	50	1,32
01.00301	10	R1/2	50	1,37
01.00302	12	R3/8	50	1,37
01.00521	12	R1/2	50	1,39

AQUA PART NO	TUBE (Metric)	THREAD (NPT)	Qty/Box	PRICE (€)
01.00323	06	NPT3/8	50	1,67
01.00324	12	NPT1/2	50	1,86

HPC-G



AQUA PART NO	TUBE (Metric)	THREAD (G)	Qty/Box	PRICE (€)
01.00324	06	G1/8	100	1,07
01.00588	06	G1/4	100	1,09
01.00303	08	G1/8	100	1,31
01.00522	08	G1/4	50	1,32
01.00523	08	G3/8	50	1,35
01.00524	08	G1/2	50	1,41
01.00525	10	G1/4	50	1,40
01.00526	10	G3/8	50	1,44
01.00527	10	G1/2	25	1,47
01.00528	12	G3/8	25	1,50
01.00529	12	G1/2	25	1,56

Female Adapter

HCF-G



AQUA PART NO	TUBE (Metric)	THREAD (G)	Qty/Box	PRICE (€)
01.00325	04	G1/8	50	1,42
01.00326	06	G1/8	50	1,28
01.00545	06	G1/4	50	1,35
01.00327	06	G3/8	50	1,51
01.00329	08	G1/8	50	1,35
01.00330	08	G1/4	50	1,42
01.00546	08	G3/8	50	1,51
01.00331	08	G1/2	25	1,66
01.00334	10	G1/4	50	1,56
01.00335	10	G3/8	25	1,61
01.00336	10	G1/2	25	1,70
01.00337	10	G5/8	25	1,75
01.00339	12	G1/4	50	1,56
01.00340	12	G3/8	25	1,69
01.00341	12	G1/2	25	1,74

AQUA PART NO	TUBE (Metric)	THREAD (UNF)	Qty/Box	PRICE (€)
01.00345	06	7/16-20	50	2,08
01.00116	08	7/16-20	50	11,97
01.00117	10	7/16-20	50	2,12

AQUA PART NO	TUBE (Metric)	THREAD (UNS)	Qty/Box	PRICE (€)
01.00346	06	7/16-24	50	2,02
01.00118	08	7/16-24	50	1,77

HCF-NH



AQUA PART NO	TUBE (Metric)	THREAD (NH)	Qty/Box	PRICE (€)
01.00344	06	NH 3/4	20	6,94
01.00114	08	NH 3/4	20	6,99
01.00115	10	NH 3/4	20	7,04

HCF-G

AQUA PART NO	TUBE (Metric)	THREAD (G)	Qty/Box	PRICE (€)
01.00333	08	G3/4	20	7,00
01.00338	10	G3/4	20	7,04

Black Acetal Fittings | Black

Metric size fitting is made of black acetal copolymer with food grade EPDM O-ring. They are suitable for water, liquids foods, air & gas

- One-touch type enabling easy to attach and detach, safe use
- Cork-type allowing excellent sealing function and high durability against leakage.
- Made of FDA-approved material ensuring its safety, certified as NSF 51, 61
- Food and beverage fittings with oval sleeves

Stem Adapter

HCJ



AQUA PART NO	STEM O.D (Metric)	THREAD (R)	Qty/Box	PRICE (€)
01.00359	06	R1/8	100	0,62
01.00360	06	R1/4	100	0,65
01.00361	08	R1/8	100	0,64
01.00130	08	R1/4	50	0,65
01.00131	08	R3/8	50	0,69
01.00132	10	R1/4	50	0,67
01.00133	10	R3/8	50	0,61
01.00134	10	R1/2	25	0,67
01.00135	12	R3/8	50	0,75
01.00136	12	R1/2	25	0,81

Stem Adapter

HCJ-G



AQUA PART NO	STEM O.D (Metric)	THREAD (G)	Qty/Box	PRICE (€)
01.00362	06	G1/8	100	0,62
01.00363	06	G1/4	100	0,65
01.00364	08	G1/8	100	0,55
01.00137	08	G1/4	50	0,65
01.00138	08	G3/8	50	0,59
01.00139	10	G1/4	50	0,57
01.00140	10	G3/8	50	0,61
01.00141	10	G1/2	25	0,79
01.00142	12	G3/8	50	0,75
01.00143	12	G1/2	25	0,69

Male Elbow

HPL



AQUA PART NO	TUBE (Metric)	THREAD (R)	Qty/Box	PRICE (€)
01.00550	06	R1/8	100	0,99
01.00371	06	R1/4	50	1,18
01.00157	06	R3/8	50	1,38
01.00158	08	R1/4	50	1,24
01.00159	08	R3/8	50	1,38
01.00160	10	R1/4	50	1,50
01.00161	10	R3/8	50	1,26
01.00162	12	R1/4	25	1,50
01.00163	12	R3/8	25	1,63
01.00164	12	R1/2	25	1,48

AQUA PART NO	TUBE (Metric)	THREAD (NPT)	Qty/Box	PRICE (€)
01.00372	06	NPT1/8	100	1,00
01.00373	06	NPT1/4	50	1,00
01.00374	06	NPT3/8	50	1,38

Stem Elbow

HLJ



AQUA PART NO	STEM O.D (Metric)	TUBE (Metric)	Qty/Box	PRICE (€)
01.00380	06	06	100	0,98
01.00381	06	08	100	1,26
01.00173	08	08	50	1,02
01.00174	10	06	50	1,42
01.00175	10	08	50	1,42
01.00176	10	10	50	1,29
01.00177	12	12	25	1,16

AQUA PART NO	TUBE (Inch)	TUBE (Metric)	Qty/Box	PRICE (€)
01.00385	1/4	06	100	1,26
01.00186	3/8	06	50	1,28

Stem Reducer

HGJ



AQUA PART NO	STEM O.D (Metric)	TUBE (Metric)	Qty/Box	PRICE (€)
01.00386	06	04	100	0,82
01.00387	08	04	100	1,46
01.00187	08	06	50	1,04
01.00188	08	08	50	1,11
01.00189	08	10	50	1,41
01.00190	10	06	50	1,24
01.00191	10	08	50	1,13
01.00192	12	08	25	1,58
01.00193	12	10	25	1,61

Bulkhead Connector

HMM



AQUA PART NO	TUBE (Metric)	TUBE (Metric)	Qty/Box	PRICE (€)
01.00390	06	06	50	1,65
01.00391	08	08	25	1,78
01.00392	10	10	25	1,97
01.00393	12	12	20	2,28

Union Connector

HUC



AQUA PART NO	TUBE (Metric)	TUBE (Metric)	Qty/Box	PRICE (€)
01.00398	06	04	100	1,23
01.00399	06	05	100	1,60
01.00400	06	06	100	1,32
01.00401	08	04	50	1,61
01.00402	08	06	50	1,61
01.00403	08	08	50	1,23
01.00404	10	06	50	1,46
01.00405	10	08	50	1,46
01.00406	10	10	50	1,33
01.00407	12	08	25	1,53
01.00408	12	10	25	1,53
01.00409	12	12	25	1,39

Union Elbow

HUL



AQUA PART NO	TUBE (Metric)	TUBE (Metric)	Qty/Box	PRICE (€)
01.00553	06	06	100	1,12
01.00425	08	08	50	1,37
01.00426	10	10	50	1,44
01.00427	12	12	25	1,50

Union Tee

HUT



AQUA PART NO	TUBE (Metric)	TUBE (Metric)	Qty/Box	PRICE (€)
01.00557	06	06	50	1,58
01.00558	08	08	50	1,67
01.00559	10	10	25	1,81
01.00560	12	12	20	1,89

AQUA PART NO	TUBE (Metric)	TUBE (Metric)	TUBE (Metric)	Qty/Box	PRICE (€)
01.00204	10	06	08	25	2,70
01.00205	10	06	10	25	2,34
01.00206	12	10	12	20	2,44

Two Way Divider

HUY



AQUA PART NO	TUBE (Metric)	TUBE (Metric)	Qty/Box	PRICE (€)
01.00432	06	06	50	2,09
01.00433	08	08	50	2,21
01.00434	10	08	25	2,62
01.00435	10	10	25	2,38
01.00436	12	12	20	2,49

Female Plug

HPF



AQUA PART NO	TUBE (Metric)	Qty/Box	PRICE (€)
01.00450	06	100	1,15
01.00451	08	100	1,18
01.00223	10	100	1,35
01.00224	12	50	1,47

Male Plug

HPP



AQUA PART NO	STEM O.D (Metric)	Qty/Box	PRICE (€)
01.00454	06	200	0,46
01.00455	08	100	0,49
01.00456	10	100	0,50
01.00227	12	100	0,57

Branch Stem Tee

HSJ



AQUA PART NO	STEM O.D (Metric)	TUBE (Metric)	Qty/Box	PRICE (€)
01.00211	06	06	50	1,75
01.00212	08	08	50	1,84
01.00067	10	10	25	1,94
01.00055	12	12	20	2,10

Union Cross

HZA



AQUA PART NO	TUBE (Metric)	TUBE (Metric)	Qty/Box	PRICE (€)
01.00229	06	06	25	3,37
01.00107	08	08	20	3,66
01.00108	10	10	20	4,37

Barb Connector

HCBB



AQUA PART NO	TUBE (Metric)	Stem I.D (Metric)	Qty/Box	PRICE (€)
01.00099	12	10	25	1,77

Stem Tee

HTJ



AQUA PART NO	STEM O.D (Metric)	TUBE (Metric)	Qty/Box	PRICE (€)
01.00215	08	08	25	1,88

Stem Barb Connector

HCJB



AQUA PART NO	STEM O.D (Metric)	TUBE I.D (Metric)	Qty/Box	PRICE (€)
01.00442	06	06	100	0,69
01.00443	10	10	100	0,89

Stem Barb Elbow Connector

HLJB



AQUA PART NO	STEM O.D (Metric)	TUBE I.D (Metric)	Qty/Box	PRICE (€)
01.00447	10	06	100	0,72
01.00448	10	08	100	0,72

Fittings For Water Application

INCH FITTINGS



Gray Acetal Fittings | Gray

Inch size fitting is made of gray acetal copolymer with food grade EPDM O-ring. They are suitable for water, liquids, air & gas.

White Acetal Fittings | White

Both sizes (metric & inch) are made of white acetal copolymer with food grade EPDM O-ring. They are suitable for water, liquids, air & gas.

PUSH-IN FITTINGS

Inch Fitting

Male Connector

HPC

AQUA PART NO	TUBE (Inch)	THREAD (NPT)	Qty/Box	PRICE (€)
01.00306	5/32	NPT1/8	100	1,00
01.00307	5/32	NPT1/4	100	1,02
01.00308	3/16	NPT1/8	100	1,00
01.00309	3/16	NPT1/4	100	1,02
01.00531	1/4	NPT1/8	100	1,18
01.00592	1/4	NPT1/4	100	1,03
01.00593	1/4	NPT3/8	50	1,04
01.00589	1/4	NPT1/2	50	1,41
01.00532	5/16	NPT1/8	50	1,23
01.00533	5/16	NPT1/4	50	1,25
01.00310	5/16	NPT3/8	50	1,32
01.00311	5/16	NPT1/2	50	1,59
01.00312	3/8	NPT1/8	50	1,31
01.00313	3/8	NPT1/4	50	1,32
01.00314	3/8	NPT3/8	50	1,12
01.00534	3/8	NPT1/2	50	1,33
01.00590	1/2	NPT3/8	50	1,33
01.00591	1/2	NPT1/2	25	1,36

AQUA PART NO	TUBE (Inch)	THREAD (R)	Qty/Box	PRICE (€)
01.00594	1/4	R1/8	100	1,23
01.00595	1/4	R1/4	100	1,17
01.00535	1/4	R3/8	50	1,35
01.00536	3/8	R1/4	50	1,21
01.00537	3/8	R3/8	50	1,23
01.00538	1/2	R3/8	50	1,35
01.00539	1/2	R1/2	25	1,84

AQUA PART NO	TUBE (Inch)	THREAD (G)	Qty/Box	PRICE (€)
01.00315	3/16	G1/8	100	1,26
01.00540	1/4	G1/8	100	1,17
01.00541	1/4	G1/4	100	1,42
01.00316	5/16	G1/8	100	1,19
01.00317	5/16	G1/4	50	1,32
01.00318	5/16	G3/8	50	1,35
01.00319	3/8	G1/8	50	1,55
01.00320	3/8	G1/4	50	1,55
01.00542	3/8	G3/8	50	1,34
01.00543	1/2	G3/8	25	1,71
01.00544	1/2	G1/2	25	1,86

HPC-MFL

AQUA PART NO	TUBE (Inch)	THREAD (MFL)	Qty/Box	PRICE (€)
01.00322	3/8	MFL1/4	50	1,91

*MFL02 Corresponds to a UNF 7/16-20

Female Adapter

HCF

AQUA PART NO	TUBE (Inch)	THREAD (NPT)	Qty/Box	PRICE (€)
01.00547	1/4	NPT1/4	50	1,62
01.00347	5/16	NPT1/4	50	1,38
01.00348	3/8	NPT1/4	50	1,43

AQUA PART NO	TUBE (Inch)	THREAD (G)	Qty/Box	PRICE (€)
01.00349	1/4	G3/8	50	1,41
01.00350	1/4	G1/2	25	1,55
01.00355	5/16	G1/2	50	1,87
01.00119	5/16	G5/8	25	1,88
01.00548	3/8	G3/8	25	1,50
01.00352	3/8	G1/2	25	1,87
01.00120	3/8	G1/2	25	1,59
01.00353	3/8	G5/8	25	1,46
01.00121	3/8	G5/8	25	1,72
01.00549	1/2	G1/2	25	1,62

AQUA PART NO	TUBE (Inch)	THREAD (UNF)	Qty/Box	PRICE (€)
01.00124	5/16	7/16-20	50	1,67
01.00357	1/4	7/16-20	50	1,97
01.00125	3/8	7/16-20	50	1,23

AQUA PART NO	TUBE (Inch)	THREAD (UN)	Qty/Box	PRICE (€)
01.00128	3/8	1/2-16	50	1,47
01.00129	1/2	1/2-16	25	1,55

AQUA PART NO	TUBE (Inch)	THREAD (UNS)	Qty/Box	PRICE (€)
01.00126	5/16	7/16-24	50	2,09
01.00358	1/4	7/16-24	50	2,02
01.00127	3/8	7/16-24	50	2,12

HCF-NH

AQUA PART NO	TUBE (Inch)	THREAD (NH)	Qty/Box	PRICE (€)
01.00356	1/4	NH3/4	20	6,54
01.00122	5/16	NH3/4	20	6,99
01.00123	3/8	NH3/4	20	7,04

HCF-G

AQUA PART NO	TUBE (Inch)	THREAD (G)	Qty/Box	PRICE (€)
01.00351	1/4	G3/4	20	6,54
01.00354	3/8	G3/4	20	4,99

Stem Adapter

HCJ



AQUA PART NO	STEM O.D (Inch)	THREAD (NPT)	Qty/Box	PRICE (€)
01.00365	5/32	NPT1/8	100	0,57
01.00366	5/32	NPT1/4	100	0,59
01.00367	3/16	NPT1/8	100	0,67
01.00368	1/4	NPT1/8	100	0,57
01.00369	1/4	NPT1/4	100	0,60
01.00370	5/16	NPT1/8	100	0,59
01.00148	5/16	NPT1/4	50	0,72
01.00149	5/16	NPT3/8	50	0,75
01.00150	3/8	NPT1/4	50	0,61
01.00151	3/8	NPT3/8	50	0,66
01.00152	1/2	NPT3/8	50	0,69
01.00153	1/2	NPT1/2	25	0,86

Male Elbow

HPL



AQUA PART NO	TUBE (Inch)	THREAD (NPT)	Qty/Box	PRICE (€)
01.00376	5/32	NPT1/8	100	1,16
01.00377	3/16	NPT1/8	100	1,16
01.00378	1/4	NPT1/8	100	1,17
01.00379	1/4	NPT1/4	50	1,00
01.00165	1/4	NPT3/8	50	1,23
01.00166	5/16	NPT1/4	50	1,25
01.00167	5/16	NPT3/8	50	1,27
01.00168	3/8	NPT1/4	50	1,33
01.00169	3/8	NPT3/8	50	1,37
01.00170	1/2	NPT3/8	25	1,45
01.00171	1/2	NPT1/2	25	1,34

AQUA PART NO	TUBE (Inch)	THREAD (R)	Qty/Box	PRICE (€)
01.00172	3/8	R3/8	50	1,37

Stem Elbow

HLJ



AQUA PART NO	STEM O.D (Inch)	TUBE (Inch)	Qty/Box	PRICE (€)
01.00382	5/32	5/32	100	0,94
01.00383	3/16	3/16	100	0,96
01.00384	1/4	1/4	100	0,98
01.00180	1/4	5/16	50	1,35
01.00181	5/16	5/16	50	1,22
01.00182	3/8	1/4	50	1,16
01.00183	3/8	5/16	50	1,26
01.00184	3/8	3/8	50	1,30
01.00185	1/2	1/2	25	1,37

Stem Reducer

HGJ



AQUA PART NO	STEM O.D (Inch)	TUBE (Inch)	Qty/Box	PRICE (€)
01.00388	1/4	5/32	100	0,91
01.00389	5/16	1/4	100	0,83
01.00202	5/16	3/8	50	1,62
01.00197	3/8	3/16	50	1,09
01.00198	3/8	1/4	50	1,13
01.00199	3/8	5/16	50	1,15
01.00203	3/8	1/2	50	1,57
01.00200	1/2	5/16	50	1,36
01.00201	1/2	3/8	50	1,40
01.00094	1/2	15	20	2,59

Bulkhead Connector

HMM



AQUA PART NO	TUBE (Inch)	TUBE (Inch)	Qty/Box	PRICE (€)
01.00394	1/4	1/4	50	1,70
01.00395	3/8	3/8	25	2,01
01.00396	1/2	1/2	20	2,32

AQUA PART NO	TUBE (Inch)	TUBE (Metric)	Qty/Box	PRICE (€)
01.00397	1/4	06	06	1,78

Union Connector

HUC



AQUA PART NO	TUBE (Inch)	TUBE (Inch)	Qty/Box	PRICE (€)
01.00413	5/32	5/32	100	1,23
01.00414	3/16	3/16	100	1,24
01.00415	1/4	1/4	100	1,48
01.00416	5/16	5/32	50	1,79
01.00417	5/16	1/4	50	1,58
01.00418	5/16	5/16	50	1,61
01.00419	3/8	3/16	50	2,07
01.00551	3/8	1/4	50	1,76
01.00420	3/8	5/16	50	2,07
01.00421	3/8	3/8	50	1,89
01.00422	1/2	5/16	25	2,16
01.00552	1/2	3/8	25	1,83
01.00423	1/2	1/2	25	1,96

AQUA PART NO	TUBE (Inch)	TUBE (Metric)	Qty/Box	PRICE (€)
01.00424	1/4	06	100	1,48

Union Elbow

HUL



AQUA PART NO	TUBE (Inch)	TUBE (Inch)	Qty/Box	PRICE (€)
01.00556	1/4	1/4	100	1,21
01.00428	3/8	3/8	50	1,73
01.00429	1/2	1/2	25	1,95

Union Tee

HUT



AQUA PART NO	TUBE (Inch)	TUBE (Inch)	TUBE (Inch)	Qty/Box	PRICE (€)
01.00563	1/4	1/4	1/4	50	1,76
01.00564	3/8	3/8	3/8	25	2,01
01.00565	1/2	1/2	1/2	20	2,11

AQUA PART NO	TUBE (Inch)	TUBE (Inch)	TUBE (Inch)	Qty/Box	PRICE (€)
01.00430	3/8	1/4	3/8	25	2,62
01.00431	1/2	3/8	1/2	25	2,53

AQUA PART NO	TUBE (Inch)	TUBE (Metric)	TUBE (Inch)	Qty/Box	PRICE (€)
01.00210	3/8	10	3/8	25	2,75
01.00209	3/8	08	3/8	25	2,69

Two Way Divider

HUY



AQUA PART NO	TUBE (Inch)	TUBE (Inch)	Qty/Box	PRICE (€)
01.00437	1/4	1/4	50	2,07
01.00438	3/8	3/8	25	2,37
01.00439	1/2	1/2	20	2,69

Female Plug

HPF



AQUA PART NO	TUBE (Inch)	Qty/Box	PRICE (€)
01.00452	1/4	100	1,15
01.00453	3/8	100	1,35
01.00226	1/2	50	1,47

Stem U-Bend

HBUJ



AQUA PART NO	TUBE (Inch)	Qty/Box	PRICE (€)
01.00088	3/8	15	3,60

Three Way Divider

HTWD



AQUA PART NO	TUBE (Inch)	TUBE (Inch)	Qty/Bag	PRICE (€)
01.00056	1/2	3/8	20	5,23
01.00057	1/2	1/2	20	5,49

Bulk packaging

U-Band

HBU



AQUA PART NO	TUBE (Inch)	TUBE (Inch)	Qty/Box	PRICE (€)
01.00218	3/8	3/8	25	2,35
01.00097	1/2	1/2	20	2,48

Stem Barb Elbow Connector

HLJB



AQUA PART NO	STEM O.D (Inch)	TUBE I.D (Inch)	Qty/Box	PRICE (€)
01.00449	3/8	3/8	100	0,74

Stem Barb Connector

HCJB



AQUA PART NO	STEM O.D (Inch)	TUBE I.D (Inch)	Qty/Box	PRICE (€)
01.00444	1/4	1/4	100	0,69
01.00445	3/8	3/8	100	0,71
01.00446	1/2	1/2	50	0,75

Male Plug

HPP



AQUA PART NO	STEM O.D (Inch)	Qty/Box	PRICE (€)
01.00457	1/4	200	0,46
01.00458	3/8	100	0,50
01.00459	1/2	100	0,57

Branch Stem Tee

HSJ



AQUA PART NO	STEM O.D (Inch)	TUBE (Inch)	Qty/Box	PRICE (€)
01.00213	1/4	1/4	50	1,75
01.00214	3/8	3/8	25	1,94
01.00095	1/2	1/2	20	2,10

Stem Tee

HTJ



AQUA PART NO	STEM O.D (Inch)	TUBE (Inch)	Qty/Box	PRICE (€)
01.00217	3/8	3/8	25	1,94

Cooling Mainfold

HUTT



AQUA PART NO	TUBE (Metric)	TUBE (Inch)	TUBE (Metric)	Qty/Bag	PRICE (€)
01.00054	15	3/8	15	20	7,58

Bulk packaging

AQUA PART NO	TUBE (Metric)	TUBE (Inch)	TUBE (Metric)	Qty/Bag	PRICE (€)
01.00053	1/2	3/8	1/2	20	6,73

Bulk packaging

F/F Reducer

HUFF



AQUA PART NO	THREAD (G)	THREAD (G)	Qty/Bag	PRICE (€)
01.00440	G1/4	G3/4	100	1,99
01.00441	G3/8	G3/4	100	2,52

Bulk packaging

Stem Barb Connector

HCJB



AQUA PART NO	STEM O.D (Inch)	TUBE I.D (Inch)	Qty/Box	PRICE (€)
01.00444	1/4	1/4	100	0,69
01.00445	3/8	3/8	100	0,71
01.00446	1/2	1/2	50	0,75

AQUA GENESI

FLUID FIT CATALOGUE

SWIVEL TYPE FITTINGS

SWIVEL TYPE FITTINGS

Inch Fitting

Swivel Male Elbow

HRPL	AQUA PART NO	TUBE (Metric)	THREAD (R)	Qty/Box	PRICE (€)
	01.00472	06	R1/8	50	2,18
	01.00580	06	R1/4	50	1,88
	01.00473	08	R1/8	25	2,25
	01.00474	08	R1/4	25	2,26
	01.00475	08	R3/8	25	2,31
	01.00476	10	R1/4	25	2,35
	01.00477	10	R3/8	25	2,41
	01.00478	10	R1/2	20	2,49
	01.00479	12	R3/8	20	2,52
	01.00480	12	R1/2	20	2,60

Swivel Male Run Tee

HRST	AQUA PART NO	TUBE (Metric)	THREAD (R)	Qty/Box	PRICE (€)
	01.00256	06	R1/8	50	2,68
	01.00509	06	R1/4	25	2,712
	01.00583	08	R1/8	25	2,38
	01.00079	08	R1/4	25	2,82
	01.00080	08	R3/8	25	2,87
	01.00081	10	R1/4	25	2,55
	01.00257	10	R3/8	20	3,07
	01.00510	10	R1/2	20	3,15
	01.00258	12	R3/8	15	3,20
	01.00511	12	R1/2	12	3,28

Swivel Male Elbow

HRPL	AQUA PART NO	TUBE (Inch)	THREAD (NPT)	Qty/Box	PRICE (€)
	01.00246	5/32	NPT1/4	50	2,31
	01.00581	1/4	NPT1/8	50	1,99
	01.00491	1/4	NPT1/4	50	2,39
	01.00073	5/16	NPT1/8	25	2,48
	01.00074	5/16	NPT1/4	25	2,13
	01.00075	5/16	NPT3/8	25	2,54
	01.00492	3/8	NPT1/4	25	2,73
	01.00493	3/8	NPT3/8	25	2,79
	01.00494	1/2	NPT3/8	20	3,06
	01.00495	1/2	NPT1/2	20	3,14

Swivel Male Run Tee

HRST	AQUA PART NO	TUBE (Inch)	THREAD (NPT)	Qty/Box	PRICE (€)
	01.00262	5/32	NPT1/8	50	2,92
	01.00263	5/32	NPT1/4	50	2,96
	01.00264	1/4	NPT1/8	50	2,95
	01.00515	1/4	NPT1/4	25	3,00
	01.00085	5/16	NPT1/8	25	3,10
	01.00086	5/16	NPT1/4	25	3,13
	01.00087	5/16	NPT3/8	25	2,69
	01.00265	3/8	NPT1/4	25	3,33
	01.00293	3/8	NPT3/8	20	3,39
	01.00091	1/2	NPT3/8	15	3,01
	01.00113	1/2	NPT1/2	12	3,62

HRPL-G	AQUA PART NO	TUBE (Metric)	THREAD (G)	Qty/Box	PRICE (€)
	01.00481	06	G1/8	50	2,18
	01.00482	06	G1/4	50	2,21
	01.00483	08	G1/8	25	2,25
	01.00484	08	G1/4	25	2,26
	01.00485	08	G3/8	25	2,31
	01.00486	08	G1/4	25	2,35
	01.00487	10	G3/8	25	2,41
	01.00488	10	G1/2	20	2,49
	01.00489	12	G3/8	20	2,52
	01.00490	12	G1/2	20	2,60

HRST-G	AQUA PART NO	TUBE (Metric)	THREAD (G)	Qty/Box	PRICE (€)
	01.00259	06	G1/8	50	2,68
	01.00512	06	G1/4	25	2,72
	01.00584	08	G1/8	25	2,38
	01.00082	08	G1/4	25	2,82
	01.00083	08	G3/8	25	2,44
	01.00084	10	G1/4	25	3,00
	01.00260	10	G3/8	20	3,07
	01.00513	10	G1/2	20	3,15
	01.00261	12	G3/8	15	3,20
	01.00514	12	G1/2	12	3,28

Swivel Male Branch Tee

HRPT	AQUA PART NO	TUBE (Inch)	THREAD (NPT)	Qty/Box	PRICE (€)
	01.00253	5/32	NPT1/4	50	2,94
	01.00506	1/4	NPT1/8	50	2,95
	01.00582	1/4	NPT1/4	25	2,55
	01.00076	5/16	NPT1/8	25	3,10
	01.00077	5/16	NPT1/4	25	3,13
	01.00078	5/16	NPT3/8	25	3,16
	01.00254	3/8	NPT1/4	25	3,33
	01.00507	3/8	NPT3/8	20	3,39
	01.00255	1/2	NPT3/8	15	3,54
	01.00508	1/2	NPT1/2	12	3,62

Swivel Male Y

HRWT	AQUA PART NO	TUBE (Inch)	THREAD (NPT)	Qty/Box	PRICE (€)
	01.00280	5/32	NPT1/8	50	2,84
	01.00281	5/32	NPT1/4	50	2,85
	01.00282	1/4	NPT1/8	50	2,95
	01.00283	1/4	NPT1/4	25	3,00
	01.00284	5/16	NPT1/8	25	3,11
	01.00285	5/16	NPT1/4	25	3,14
	01.00286	5/16	NPT3/8	25	3,17
	01.00287	3/8	NPT1/4	25	3,33
	01.00288	3/8	NPT3/8	25	3,39
	01.00294	1/2	NPT3/8	15	3,75
	01.00295	1/2	NPT1/2	12	3,83

Swivel Male Branch Tee

HRPT	AQUA PART NO	TUBE (Metric)	THREAD (R)	Qty/Box	PRICE (€)
	01.00498	06	R1/8	50	2,68
	01.00499	06	R1/4	25	2,72
	01.00247	08	R1/8	25	2,80
	01.00500	08	R1/4	25	2,82
	01.00248	08	R3/8	25	2,87
	01.00249	10	R1/4	25	3,00
	01.00501	10	R3/8	20	3,07
	01.00291	10	R1/2	20	3,15
	01.00089	12	R3/8	15	3,20
	01.00111	12	R1/2	12	3,28

Swivel Male Y

HRWT	AQUA PART NO	TUBE (Metric)	THREAD (R)	Qty/Box	PRICE (€)
	01.00266	06	R1/8	50	2,90
	01.00267	06	R1/4	25	2,94
	01.00268	08	R1/8	25	3,05
	01.00269	08	R1/4	25	3,06
	01.00270	08	R3/8	25	3,11
	01.00271	10	R1/4	25	3,26
	01.00272	10	R3/8	25	3,33
	01.00109	10	R1/2	20	2,89
	01.00092	12	R3/8	15	2,95
	01.00065	12	R1/2	12	3,01

HRPT-G	AQUA PART NO	TUBE (Metric)	THREAD (G)	Qty/Box	PRICE (€)
	01.00502	06	G1/8	50	2,68
	01.00503	06	G1/4	25	2,72
	01.00250	08	G1/8	25	2,80
	01.00504	08	G1/4	25	2,82
	01.00251	08	G3/8	25	2,87
	01.00252	08	G1/4	25	3,00
	01.00505	10	G3/8	20	3,07
	01.00292	10	G1/2	20	3,15
	01.00090	12	G3/8	15	3,20
	01.00112	12	G1/2	12	3,28

HRWT-G	AQUA PART NO	TUBE (Metric)	THREAD (G)	Qty/Box	PRICE (€)
	01.00273	06	G1/8	50	2,90
	01.00274	06	G1/4	25	2,94
	01.00275	08	G1/8	25	3,05
	01.00276	08	G1/4	25	3,06
	01.00277	08	G3/8	25	3,11
	01.00278	10	G1/4	25	3,26
	01.00279	10	G3/8	25	3,33
	01.00110	10	G1/2	20	3,40
	01.00093	12	G3/8	15	3,47
	01.00066	12	G1/2	12	3,55

Adaptability

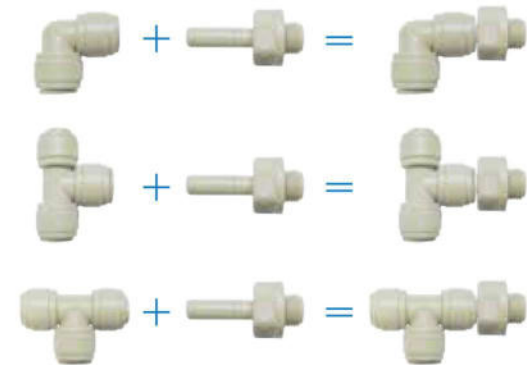

Color Codes



LARGE SIZE FITTINGS

Fittings for Water Application

Male Connector

HPC-G	AQUA PART NO	TUBE (Metric)	THREAD (G)	Qty/Bag	PRICE (€)
	01.00304	15	G1/2	20	3,05
	01.00305	15	G3/4	20	4,47
	01.00530	22	G3/4	20	4,60

Female Adapter

HCF-G	AQUA PART NO	TUBE (Metric)	THREAD (G)	Qty/Bag	PRICE (€)
	01.00342	15	G1/2	25	2,04
	01.00343	15	G3/4	20	2,89

Stem Adapter

HCJ-G	AQUA PART NO	STEM O.D (Metric)	THREAD (G)	Qty/Bag	PRICE (€)
	01.00144	15	G3/8	25	0,95
	01.00145	15	G1/2	25	1,13
	01.00146	22	G1/2	20	1,62
	01.00147	22	G3/4	20	1,75

Stem Elbow

HLJ	AQUA PART NO	STEM O.D (Metric)	TUBE (Metric)	Qty/Bag	PRICE (€)
	01.00178	15	15	20	2,46
	01.00179	22	22	20	3,07

LARGE SIZE FITTINGS

Metric Fitting

Stem Adapter

HGJ	AQUA PART NO	STEM O.D (Metric)	TUBE (Metric)	Qty/Bag	PRICE (€)
	01.00194	15	10	25	1,93
	01.00195	15	12	25	1,93
	01.00196	22	15	20	2,84

Union Connector

HUC	AQUA PART NO	TUBE (Metric)	TUBE (Metric)	Qty/Bag	PRICE (€)
	01.00410	15	15	20	2,73
	01.00411	22	22	9	3,99

Union Elbow

HUL	AQUA PART NO	TUBE (Metric)	TUBE (Metric)	Qty/Bag	PRICE (€)
	01.00554	15	15	20	3,06
	01.00555	22	22	9	5,57

Union Tee

HUT	AQUA PART NO	TUBE(M) ØD1	TUBE(M) ØD2	Qty/Bag	PRICE (€)
	01.00561	15	15	9	4,40
	01.00207	22	12	6	10,15
	01.00208	22	15	6	10,15
	01.00562	22	22	6	7,83

Female Plug

HPF	AQUA PART NO	TUBE(Metric)	Qty/Bag	PRICE (€)
	01.00225	15	50	1,98
	01.00098	22	20	2,03

Male Plug

HPP	AQUA PART NO	STEM O.D (Metric)	Qty/Bag	PRICE (€)
	01.00228	15	50	0,75
	01.00072	22	25	0,89

Barb Connector

HCBB	AQUA PART NO	TUBE (Metric)	STEM I.D (Inch)	Qty/Bag	PRICE (€)
	01.00100	15	1/2	20	1,29
	01.00101	22	1/2	20	2,16
	01.00102	22	3/4	20	2,34

Large Size Fitting

- One-touch type enabling easy to attach and detach, safe use
- Cork-type allowing excellent sealing function and high durability against leakage
- FDA-approved material ensuring its safety, certified as NSF 51, 61
- Food and beverage fittings with oval sleeves

SINGLE CHECK VALVES

(NON-RETURN VALVE)

Structural Diagram

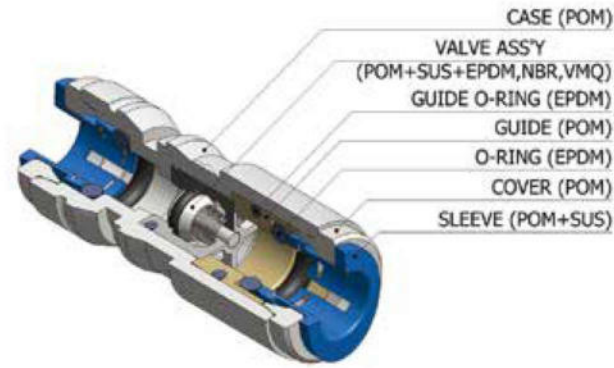

Applications

- This Valve allows one way fluid flow and blocks the reverse flow

Features

- Compact size and convenient to use in a narrow space
- Cracking Pressure 0.02~0.04bar
- Quick Installation and easy maintenance

Working Pressure & Temperatures

°C	Φ	5/32 ~ 1/2	4mm~12mm
25°C		10Bar	10Bar
65°C		7Bar	7Bar

Metric Fitting

Inch Fitting

HCVU	AQUA PART NO	TUBE (Metric)	TUBE (Metric)	Qty/Box	PRICE (€)
	01.00460	06	06	50	9,36
	01.00461	08	08	50	9,61
	01.00462	10	10	25	9,79
	01.00463	12	12	25	10,10

HCVU	AQUA PART NO	TUBE (Inch)	TUBE (Inch)	Qty/Box	PRICE (€)
	01.00464	1/4	1/4	50	9,48
	01.00465	3/8	3/8	25	9,79
	01.00466	1/2	1/2	25	10,10

FLOW CONTROL VALVES

Structural Diagram

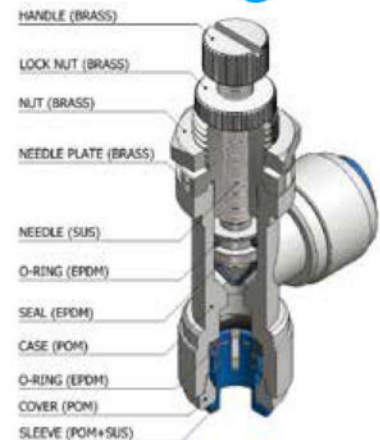

Applications

- Constant flow rate by small airflow controlling

Features

- Used for Water and Beverages
- Easy installation convenient to use
- Stable to use with frequent temperature changes

Working Pressure & Temperatures

°C	Φ	5/32 ~ 1/2	4mm~12mm
25°C		10Bar	10Bar
65°C		7Bar	7Bar

Metric Fitting

Inch Fitting

Flow Control Elbow Union

HSLB

AQUA PART NO	TUBE (Metric)	TUBE (Metric)	Qty/Box	PRICE (€)
01.00219	06	06	50	10,08
01.00068	10	10	25	12,06



Flow Control Elbow Union

HSLB

AQUA PART NO	TUBE (Inch)	TUBE (Inch)	Qty/Box	PRICE (€)
01.00220	1/4	1/4	50	10,08
01.00069	3/8	3/8	25	10,23



Flow Control Union Connector

HSTB

AQUA PART NO	TUBE (Metric)	TUBE (Metric)	Qty/Box	PRICE (€)
01.00221	06	06	50	10,08
01.00070	10	10	25	10,23



Flow Control Union Connector

HSTB

AQUA PART NO	TUBE (Inch)	TUBE (Inch)	Qty/Box	PRICE (€)
01.00222	1/4	1/4	50	10,08
01.00071	3/8	3/8	25	10,23



Flowrate

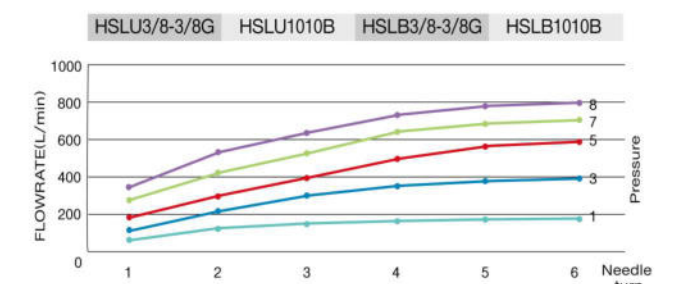
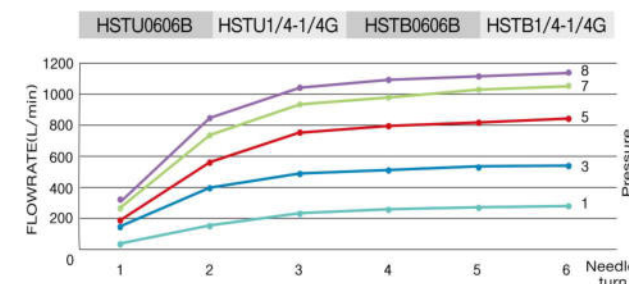
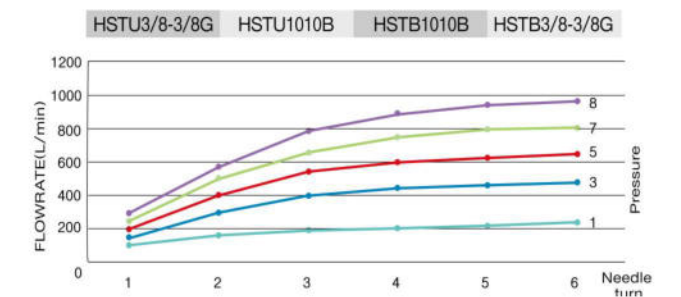
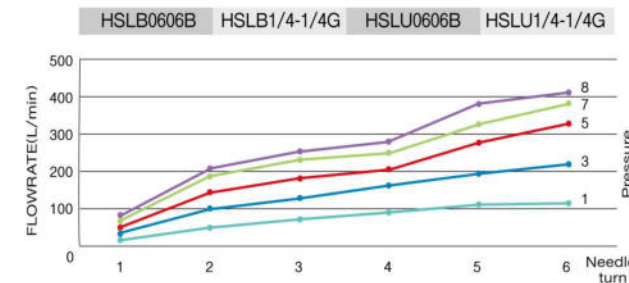

BALL VALVES

(SHUT-OFF VALVE)

Structural Diagram

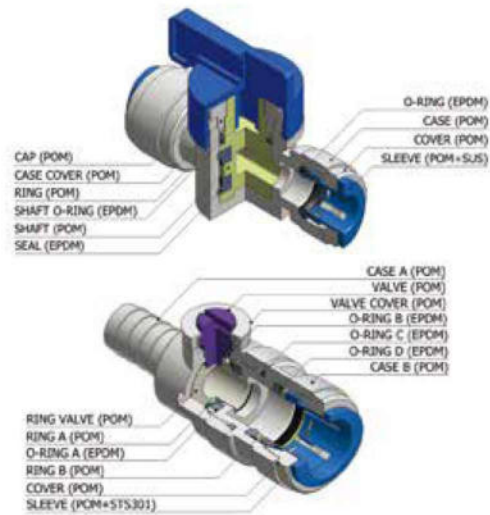

Applications

- The user switches On-Off valve to supply compressed air or fluid
- Suitable for air and water

Features

- Compact size and convenient to use in a narrow space
- Some valves are available without or with mouting clip
- Valves using for short or long handles depending on the application.

Working Pressure & Temperatures

°C	Φ	5/32 ~ 1/2	4mm~12mm	15mm~22mm
25°C		10Bar	10Bar	7Bar
65°C		7Bar	7Bar	5Bar

FILTERS

Structural Diagram

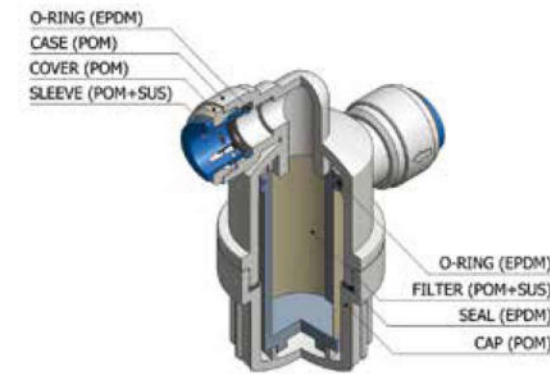

Applications

- It is stainless steel filter mesh(applied to 100 mesh or 200 mesh) and it filters out fine impurities.

Features

- The screw typed cap of the filer has an easy installation and maintenance

Working Pressure & Temperatures

°C	Φ	5/32 ~ 1/2	4mm~12mm
25°C		10Bar	10Bar
65°C		7Bar	7Bar

Ball Valve (Shut-Off Valve)

HBVU



AQUA PART NO	TUBE (Metric)	TUBE (Metric)	Qty/Box	PRICE (€)
01.00566	06	06	25	5,48
01.00567	08	08	25	5,56
01.00467	10	10	15	7,05
01.00468	12	12	15	7,21

Ball Valve (Short Handle)

HBVU-S



AQUA PART NO	TUBE (Metric)	TUBE (Metric)	Qty/Box	PRICE (€)
01.00566	06	06	25	5,48
01.00567	08	08	25	5,55
01.00467	10	10	15	7,05
01.00468	12	12	15	7,21

Ball Valve (Shut-Off Valve)

HBVU



AQUA PART NO	TUBE (Inch)	TUBE (Inch)	Qty/Box	PRICE (€)
01.00469	1/2	1/2	15	7,21

Ball Valve (Short Handle)

HBVU-S



AQUA PART NO	TUBE (Inch)	TUBE (Inch)	Qty/Box	PRICE (€)
01.00568	1/4	1/4	25	5,48
01.00569	3/8	3/8	15	5,98

Barb Connector Valve

HCVB



AQUA PART NO	TUBE (Metric)	Tube I.D (Inch)	Qty/Bag	PRICE (€)
01.00058	15	1/2	20	4,74
01.00059	22	1/2	20	5,61
01.00060	22	3/4	20	5,72

Bulk packaging

Angle Ball Valve

HASV



AQUA PART NO	TUBE (Inch)	TUBE (Inch)	Qty/Bag	PRICE (€)
01.00289	3/8	3/8	20	11,24

Bulk packaging

Female Adapter Ball Valve

HESV



AQUA PART NO	TUBE (Inch)	THREAD (G)	Qty/Bag	PRICE (€)
01.00570	3/8	G1/2	20	9,62

Bulk packaging

Faucet Ball Valve Adapter

HAAV



AQUA PART NO	TUBE (Inch)	THREAD (G)	Qty/Bag	PRICE (€)
01.00290	1/4	G1/2	20	12,47

Bulk packaging

Metric Fitting

HBMU



AQUA PART NO	TUBE (Metric)	TUBE (Metric)	Qty/Bag	PRICE (€)
01.00103	08	08	20	9,42
01.00104	10	10	20	8,93

Bulk packaging

Inch Fitting

HBMU



AQUA PART NO	TUBE (Inch)	TUBE (Inch)	Qty/Bag	PRICE (€)
01.00105	1/4	1/4	20	8,90
01.00106	3/8	3/8	20	9,42

Bulk packaging

Structural Diagram

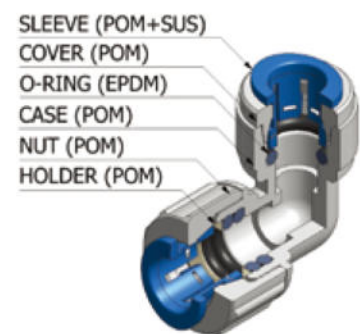

Applications

- This product is used for stainless steel and other similar plated pipe & tube

Features

- Two O-rings provide more sealing effect at high temperature
- The nut & holder provides a stronger grip when connecting the pipe, and O-ring effectively seals the fitting

Inch Fitting

Union Connector (Single)

HUCP



AQUA PART NO	TUBE (Inch)	TUBE (Inch)	Qty/Box	PRICE (€)
01.00233	1/4	5/16	50	2,18
01.00234	1/4	3/8	50	2,20
01.00231	5/16	5/16	50	2,18
01.00230	5/16	3/8	50	2,22
01.00232	5/16	1/2	50	2,26
01.00235	3/8	5/16	50	2,28
01.00236	3/8	3/8	50	2,29
01.00237	1/2	1/2	25	2,42

Inch Fitting

Elbow Union (Double)

HULS



AQUA PART NO	TUBE (Inch)	TUBE (Inch)	Qty/Box	PRICE (€)
01.00245	5/16	5/16	50	2,41

Elbow Union (Single)

HULP



AQUA PART NO	TUBE (Inch)	TUBE (Inch)	Qty/Box	PRICE (€)
01.00242	1/4	5/16	50	2,21
01.00241	1/4	3/8	50	2,22
01.00239	5/16	5/16	50	2,22
01.00240	5/16	3/8	50	2,23
01.00238	3/8	5/16	50	2,29
01.00243	3/8	3/8	50	2,32
01.00244	1/2	1/2	25	2,53

AQUA GENESI

FLUID CATALOGUE

ACCESSORIES

Metric Fitting

Locking Clip



AQUA PART NO	TUBE(Metric)	Qty/Box	PRICE (€)
01.00604	06	1000	0,08
01.00605	10	1000	0,09
01.00606	12	1000	0,09
01.00602	15	500	0,22
01.00603	22	300	0,28

Mounting Clip



AQUA PART NO	TUBE O.D	Qty/Box	PRICE (€)
01.00470	6mm or 1/4	Bulk	0,67
01.00471	10mm or 3/8	Bulk	0,78

Use example



Inch Fitting

Locking Clip



AQUA PART NO	TUBE(Inch)	Qty/Box	PRICE (€)
01.00596	1/4	1000	0,07
01.00598	3/8	1000	0,09
01.00600	1/2	1000	0,09

Spanner



AQUA PART NO	TUBE O.D	PRICE (€)
01.00585	5/32 or 3/16 or 4mm	4,12
	1/4 or 6mm	
	5/16 or 8mm	
	3/8 or 10mm	
	1/2 or 12mm	

Tube Cutter



AQUA PART NO	PRICE (€)
01.00516	18,37

POLYETHYLENE TUBE

Our tube is made of Linear Low Density Polyethylene (LLDPE) and tube can be used for wide range of temperature and pressure suitability. Fluidfit tube is NSF & ACS certified for the requirement of water & food applications



Applications

- water purification, water conditioners, ice makers, misting systems and food contact application

Features

- A wide range of temperature and pressure suitability
- Broad chemical compatibility
- PE tubing is made from FDA compliant and non contaminating materials

Specifications

- Tube Tolerance :+0.1mm/-0.1mm
- Temperature : -20°F(-29°C) ~ +150°F(66°C)

Maximum Pressure

Size	5/32"	3/16"	1/4"	5/16"	3/8"	1/2"
	4mm	5mm	6mm	8mm	10mm	12mm
Pressure	230 PSI			170 PSI		

Available Color and Sizes



Metric size tube

AQUA PART NO	Material	O.D (mm)	I.D (mm)	Reel Length(Meter)	PRICE (€)
01.00024	LLDPE	8	6	100	0,49
01.00037	LLDPE	10	7	100	0,88
01.00042	LLDPE	12	9	100	0,88

Inch size tube

AQUA PART NO	Material	O.D (mm)	I.D (mm)	Reel Length(Meter)	PRICE (€)
01.00047	LLDPE	4.76	3.17	200	1,12
01.00009	LLDPE	6.35	4.32	100	1,31
01.00016	LLDPE	9.52	6.35	100	0,88





WARNING AND CAUTION

- USE EACH PRODUCT ONLY FOR RECOMMENDED APPLICATIONS.
- OUR PRODUCTS ARE ORIGINALLY DESIGNED FOR USE WITH WATER, FOOD, OR BEVERAGE PRODUCTS. FOR OTHER CHEMICALS REFER TO CHEMICAL COMPATIBILITY DATA (CHART) PROVIDED. FOR UNLISTED CHEMICALS OR MEDIA PLEASE CONTACT US.
- DO NOT DISASSEMBLE OR MODIFY THE PRODUCTS. IT MAY CAUSE MALFUNCTION, LEAK, OR FAILURE AND VOIDS THE PRODUCT WARRANTY.
- DO NOT APPLY EXCESSIVE STRESS ON FITTING BY ROTATION, TWIST, BENDING, SHOCK. THIS MAY DAMAGE THE FITTING OR CAUSE MALFUNCTION, LEAK, OR FAILURE AND VOIDS THE PRODUCT WARRANTY.
- DO NOT USE THE PRODUCTS AT THE TEMPERATURE EXCEEDING 80°C. THIS MAY CAUSE MALFUNCTION, LEAK, OR FAILURE.
- DO NOT USE PIPE GLUE OR OTHER LIQUID SEALANTS OTHER THAN TEFLON TAPE WHEN SEALING THREADED FITTINGS.
- DO NOT PRESS COLLET TOWARD BODY OR ATTEMPT TO PULL OUT TUBING WHEN THE LINE IS PRESSURED.
- USE LOCKING CLIPS TO PREVENT UNINTENDED SEPARATION.
- WHEN TIGHTENING THREADED FITTINGS, REFER TO TORQUE DATA PROVIDED. OVER TORQUE MAY DAMAGE THE FITTING AND CAUSE LEAK OR FAILURE.
- BEFORE DISASSEMBLING TUBE CONNECTION, VERIFY IF THE LINE PRESSURE HAS BEEN REMOVED.
- OUR PRODUCTS MAY BE MODIFIED OR REDESIGNED AS TO MARKET REQUIREMENT FOR IMPROVEMENT WITHOUT NOTICE, THEREFORE THE ACTUAL PRODUCT MAY DIFFER FROM PICTURES PROVIDED.